



AXIAL FAN



EN

Calm dMEV DC 100

USER'S MANUAL

CONTENTS

Delivery set.....	6
Brief description	6
Operating guidelines.....	6
designation key	7
Installation and set-up.....	7
Fan options.....	8
Fan operation setup.....	8
Technical maintenance.....	11
Storage and transportation regulations.....	11
Manufacturer's warranty	12

BLAUBERG VENTILATOREN GmbH is happy to offer you a new innovation product, the Calm dMEV DC 100 fan. The solid team of high-qualified professionals with many years of working experience, technological innovations in design and production, high-quality components and materials from the top worldwide producers have become the precondition for the best fans in their class.

Blauberg fans are the combination of innovations, energy-efficient and low-noise operation.

This user's manual is the primary operating document intended for technical, maintenance and operations staff.

The manual contains information about purpose, technical details, operating principle, design, and installation of the Calm dMEV DC 100 unit and all its modifications. Technical and maintenance staff must have proper theoretical knowledge and practical training specific to ventilation systems as well as the necessary skills to carry out the work in accordance with labour safety and construction regulations and standards applicable in the respective territory.

The information provided in the present document is true as at the document preparation. Due to the continuous product development the company reserves the right to update the technical specifications, design or delivery package of its products.

No part of the present publication may be reproduced, uploaded or saved in reference-providing information systems or translated into other languages in any form whatsoever without the Company's prior written consent.



**READ THE USER'S MANUAL CAREFULLY BEFORE PROCEEDING WITH INSTALLATION WORKS.
COMPLIANCE WITH THE MANUAL REQUIREMENTS ENSURES RELIABLE OPERATION AND LONG
SERVICE LIFE OF THE UNIT.
KEEP THE USER'S MANUAL AVAILABLE AS LONG AS YOU USE THE UNIT. YOU MAY NEED TO RE-
READ THE INFORMATION ON THE PRODUCT SERVICING.**



FOLLOW THE USER'S MANUAL REQUIREMENTS TO ENSURE DURABLE AND TROUBLE-FREE OPERATION OF THE UNIT.

Disconnect the unit from power supply prior to any connection, servicing, maintenance, and repair operations.

Only qualified electricians with a work permit for electrical units up to 1000 V are allowed for installation and maintenance. The present user's manual should be carefully read before beginning works.

- Single-phase power mains must comply with the acting local electrical norms and standards.
- Fixed electrical wiring must be equipped with an automatic circuit breaker.
- The unit must be connected to power mains through a QF automatic circuit breaker integrated into the fixed wiring system. The gap between the circuit breaker contacts on all poles must be not less than 3 mm. Check the unit for any visible damages of the impeller and the casing before starting installation. The casing internals must be free of any foreign objects that can damage the impeller blades.
- While mounting the unit, avoid compression of the casing! Deformation of the casing may result in the motor jam and noisy operation. Misuse of the unit and any unauthorised modifications are not allowed.
- Take steps to prevent ingress of smoke, carbon monoxide, and other combustion products into the room through open chimney flues or other fire-protection devices. Sufficient air supply must be provided for proper combustion and exhaust of gases through the chimney of fuel burning equipment to prevent back drafting. Transported air must not contain any dust or other solid

impurities, sticky substances, or fibrous materials.

- Do not use the unit in a hazardous or explosive environment containing spirits, gasoline, insecticides, etc.
- Do not close or block the intake or extract vents in order to ensure the efficient air flow.
- Do not sit on the unit and do not put objects on it.
- The unit is allowed to be used by children aged from 8 years old and above and persons with reduced physical, sensory, or mental capabilities or no experience and knowledge provided that they have been given supervision or instruction regarding safe use of the unit and understand the risks involved.
- Do not allow children to play with the unit.



**THE PRODUCT MUST BE DISPOSED SEPARATELY AT THE END OF ITS SERVICE LIFE.
DO NOT DISPOSE THE UNIT AS UNSORTED MUNICIPAL WASTE.**

DELIVERY SET

Fan	— 1 pc.
Screws and dowels	— 4 pcs.
Plastic screwdriver (for all models with a timer)	— 1 pc.
User's manual	— 1 pc.
Packing box	— 1 pc.

BRIEF DESCRIPTION

The unit described herein is an axial fan for exhaust ventilation of small to medium-sized premises heated during winter.

The fan is designed for connection to $\varnothing 100$ mm air ducts.

The fan is equipped with a two-speed motor.

This fan model includes a back valve that prevents air back drafting when the fan is off.

OPERATING GUIDELINES

The fan is rated for connection to single-phase AC 220...240 V/50 Hz power mains.

Air flow direction in the system must correspond to the direction arrow on the fan casing.

Hazardous parts access and water ingress protection rating is IP34.

The fan is rated for operation at the ambient temperature ranging from +1 °C up to +45 °C.

The unit is rated as a Class II electrical appliance.

DESIGNATION KEY

Calm dMEV DC 100 X X

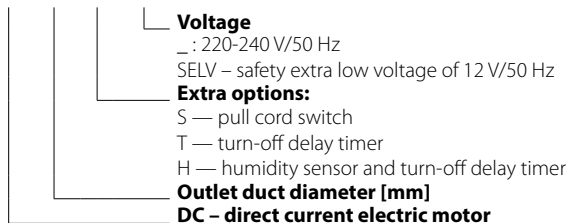

INSTALLATION AND SET-UP

The fan is designed for wall or ceiling mounting with direct air exhaust to the ventilation shaft or into the round air duct of matching diameter.

Provide the following types of installation: Diagram 1 (Fig. 5); Diagram 2 (Fig. 6); Diagram 3 (Fig. 7).

Fan installation sequence:

Step 1. Cut off power supply and make sure electricity has been turned off (Fig. 8).

Step 2. Lead the power cable to the ventilation hole (Fig. 9).

Step 3. Remove the front panel from the fan. Then remove the circuit board cover (Fig. 10).

Step 4. Mark and drill holes for mounting the fan and then install the fan (Fig. 11-14).

Step 5. Connect the fan to the electric mains according to the connections diagram (Fig. 17).

Step 6. Cover the casing with a front panel (Fig. 14) and a decorative panel (Fig. 15).

Step 7. Supply power voltage to the fan (Fig. 16).

Terminal designations on wiring diagrams

L — phase

N — 0

S — external switch

QF — circuit breaker

FAN OPTIONS

Calm dMEV DC 100 (S) T fans are equipped with a turn-off delay timer. The unit operates at the set constant speed. VT models are equipped with a cord-operated switch.

The fan switches to the intensive mode upon control voltage application to input terminal **LT** by an external switch (e.g. indoor light switch). Upon control voltage removal the fan continues to operate in the intensive mode for the period of time set by means of a DIP switch.

Calm dMEV DC 100 SELV fan is rated for connection to safe 12 V/50 Hz power mains.

Calm dMEV DC 100 (S) H fans are equipped with a turn-off and turn-on delay timer when the humidity level is exceeded. The fan switches to the intensive mode upon control voltage application to input terminal **LT** by an external switch (e.g. indoor light switch). Upon control voltage removal the fan continues to operate in the intensive mode for the period of time set by means of a DIP switch. The **S (H)** models are equipped with a cord-operated switch.

FAN OPERATION SETUP



**THE TIMER CIRCUIT IS LIVE.
MAKE SURE THE FAN IS DISCONNECTED FROM POWER SUPPLY.**

The fan is set up by changing the DIP switch position.

To access the DIP switch take off the face panel and remove the rubber plug (Fig. 18).

The fan is supplied with a special plastic screwdriver to toggle the DIP switch without damaging its components.



**DO NOT USE A METAL SCREWDRIVER, KNIFE, ETC. FOR ADJUSTMENT
OPERATIONS NOT TO DAMAGE THE CIRCUIT BOARD.**

Speed setting (Trickle)

Speed 1

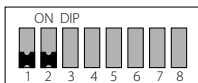

0 l/s

Speed 2

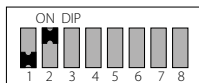

6 l/s

Speed 3

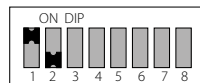

8 l/s

Speed 4

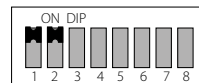

13 l/s

Intensive mode (Boost)

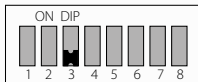

15 l/s

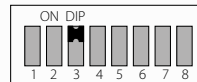

max

Turn-off delay timer

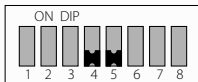

2 minutes

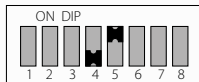

5 minutes

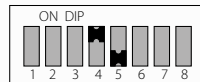

15 minutes

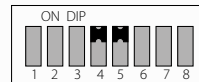

30 minutes

Humidity mode

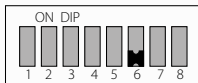

by threshold

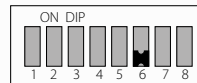

intellectual*

* — This mode provides for changing the humidity threshold and fan speed selection in automatic mode, independently choosing the optimal threshold for the room in which the fan is located. The choice of the fan operation algorithm is determined by analysing the statistical data of the humidity level in the room.

Humidity threshold

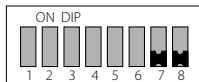

60 %

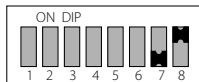

70 %

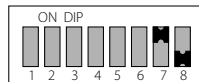

80 %

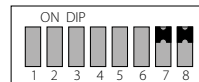

90 %

Selecting the installation diagram – Jumper 1 (J1)

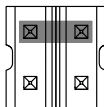

Diagram 1

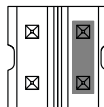

Diagram 2

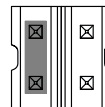

Diagram 3

See Fig. 5-7

Turn-on delay timer – Jumper 2 (J2)



0 s



60 s

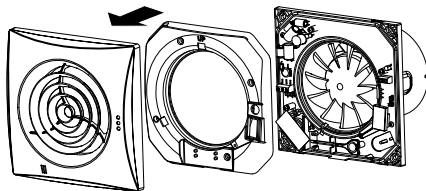

1.

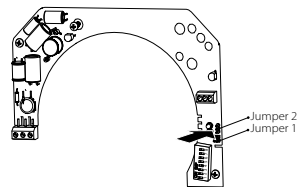

2.

TECHNICAL MAINTENANCE

The fan maintenance periodicity is at least once per 6 months.

Maintenance steps:

- Disconnect the fan from power supply and make sure electricity has been turned off (Fig. 15).
- Remove the front and the decorative panels, wipe the fan with a dry cloth or a brush (Fig. 16).
- Clean the front panel under running water (Fig. 17).
- Wipe the fan surfaces dry.
- Cover the fan with the front panel.
- Connect power supply to the fan (Fig. 18).

WARNING! Do not allow water or liquid come into contact with electric components!

STORAGE AND TRANSPORTATION REGULATIONS

- Store the unit in the manufacturer's original packaging box in a dry closed ventilated premise with temperature range from +5 °C to +40 °C.
- Storage environment must not contain aggressive vapours and chemical mixtures provoking corrosion, insulation, and sealing deformation.
- Use suitable hoist machinery for handling and storage operations to prevent possible damage to the unit.
- Follow the handling requirements applicable for the particular type of cargo.
- The unit can be carried in the original packaging by any mode of transport provided proper protection against precipitation and mechanical damage. The unit can be transported only in the working position.
- Avoid sharp blows, scratches, or rough handling during loading and unloading.
- Prior to the initial power-up after transportation at low temperatures allow the unit to warm up at room temperature for at least 3-4 hours.

MANUFACTURER'S WARRANTY

The product is in compliance with EU norms and standards on low voltage guidelines and electromagnetic compatibility. We hereby declare that the product complies with the provisions of Electromagnetic Council Directive 2014/30/EU, Low Voltage Directive 2014/35/EU and CE-marking Directive 93/68/EEC. This certificate is issued following test carried out on samples of the product referred to above.

The manufacturer hereby warrants normal operation of the unit for 60 months after the retail sale date provided the user's observance of the transportation, storage, installation, and operation regulations.

Should any malfunctions occur in the course of the unit operation through the Manufacturer's fault during the guaranteed period of operation, the user is entitled to get all the faults eliminated by the manufacturer by means of warranty repair at the factory free of charge. The warranty repair includes work specific to elimination of faults in the unit operation to ensure its intended use by the user within the guaranteed period of operation.

The faults are eliminated by means of replacement or repair of the unit components or a specific part of such unit component.

The warranty repair does not include:

- routine technical maintenance
- unit installation/dismantling
- unit setup

To benefit from warranty repair, the user must provide the unit, the user's manual with the purchase date stamp, and the payment paperwork certifying the purchase.

The unit model must comply with the one stated in the user's manual.

Contact the Seller for warranty service.

The manufacturer's warranty does not apply to the following cases:

- User's failure to submit the unit with the entire delivery package as stated in the user's manual including submission with missing component parts previously dismounted by the user.
- Mismatch of the unit model and the brand name with the information stated on the unit packaging and in the user's manual.
- User's failure to ensure timely technical maintenance of the unit.
- External damage to the unit casing (excluding external modifications as required for installation) and internal components caused by the user.

- Redesign or engineering changes to the unit.
- Replacement and use of any assemblies, parts and components not approved by the manufacturer.
- Unit misuse.
- Violation of the unit installation regulations by the user.
- Violation of the unit control regulations by the user.
- Unit connection to power mains with a voltage different from the one stated in the user's manual.
- Unit breakdown due to voltage surges in power mains.
- Discretionary repair of the unit by the user.
- Unit repair by any persons without the manufacturer's authorization.
- Expiration of the unit warranty period.
- Violation of the unit transportation regulations by the user.
- Violation of the unit storage regulations by the user.
- Wrongful actions against the unit committed by third parties.
- Unit breakdown due to circumstances of insuperable force (fire, flood, earthquake, war, hostilities of any kind, blockades).
- Missing seals if provided by the user's manual.
- Failure to submit the user's manual with the unit purchase date stamp.
- Missing payment paperwork certifying the unit purchase.



FOLLOWING THE REGULATIONS STIPULATED HEREIN WILL ENSURE A LONG AND TROUBLE-FREE OPERATION OF THE UNIT.



USERS' WARRANTY CLAIMS SHALL BE SUBJECT TO REVIEW ONLY UPON PRESENTATION OF THE UNIT, THE PAYMENT DOCUMENT AND THE USER'S MANUAL WITH THE PURCHASE DATE STAMP.

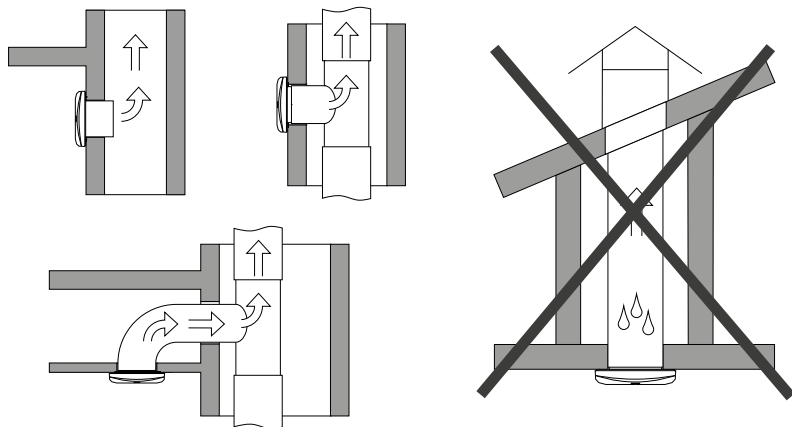
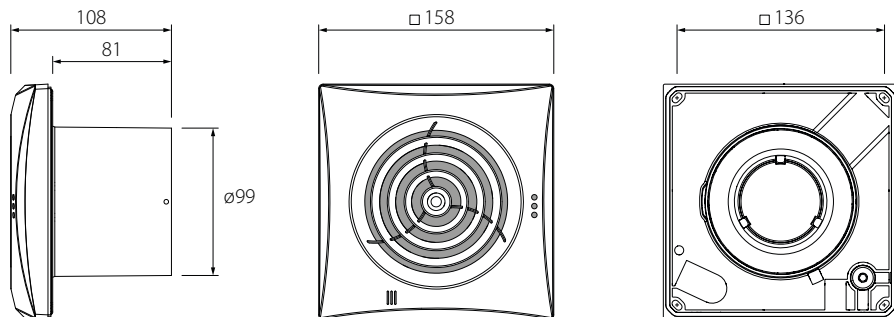
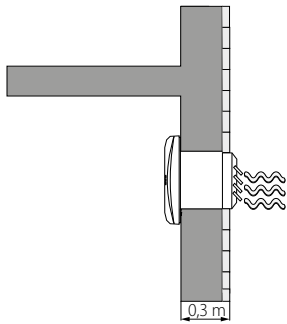
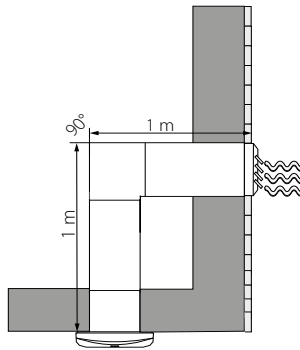

Diagram 1



5.

Diagram 2



6.

Diagram 3

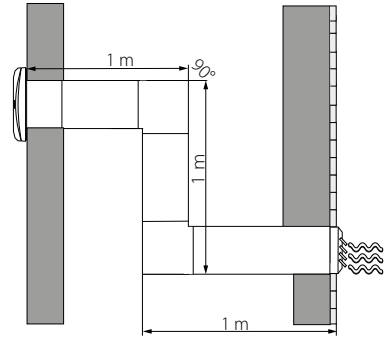

7.

(Top view)

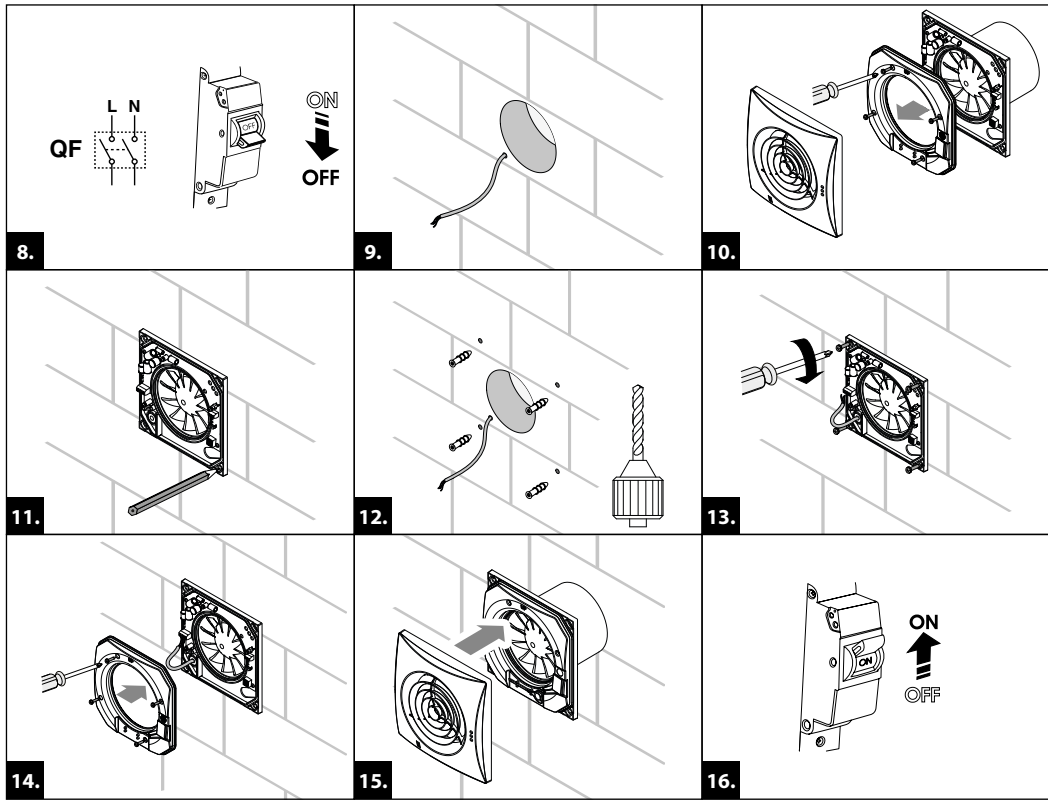

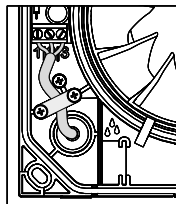
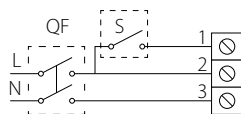

17.

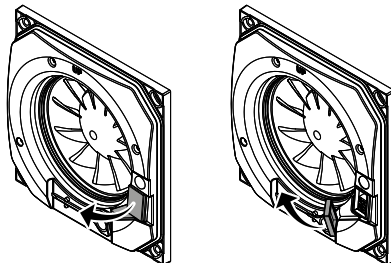

18.

Calm dMEV DC 100 T, ST

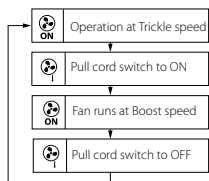

19.

Calm dMEV DC 100 T, ST

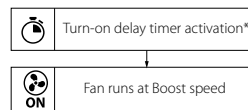
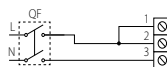

*— See the turn-on delay timer wiring diagram on page 10.

20.

Calm dMEV DC 100 T, ST

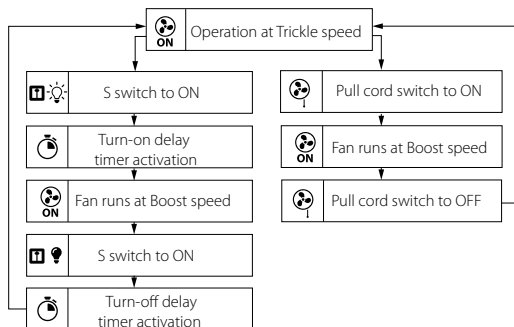
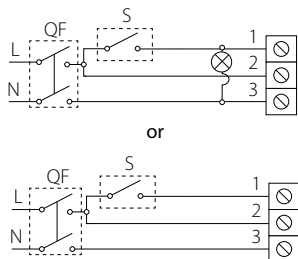

21.

Calm dMEV DC 100 H, SH

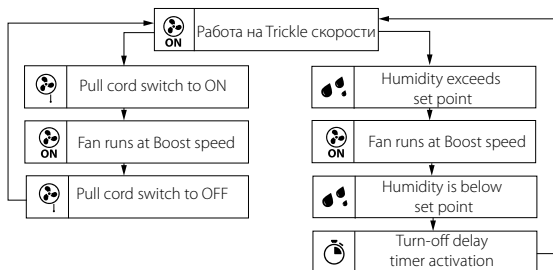

22.

Calm dMEV DC 100 H, SH

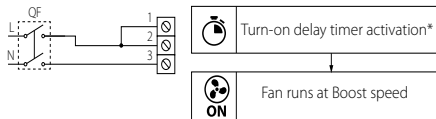

*— See the turn-on delay timer wiring diagram on page 10.

23.

Calm dMEV DC 100 H, SH

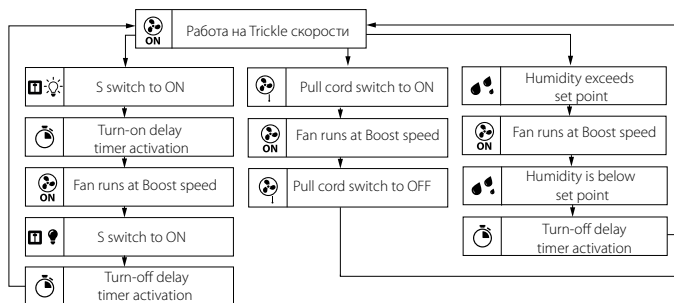
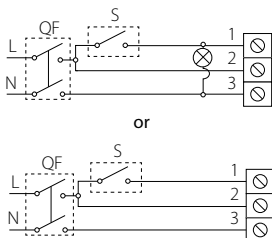

24.

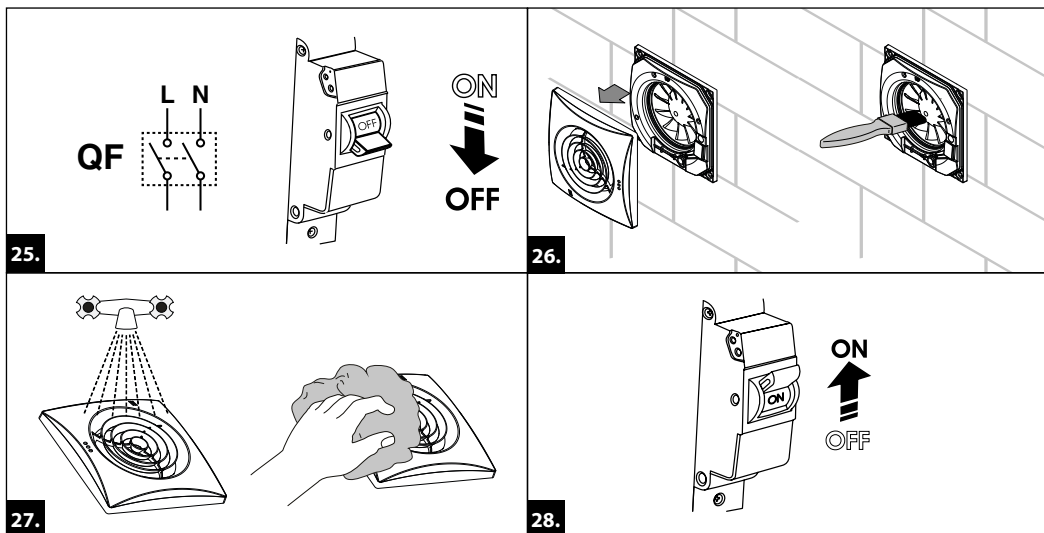

Quality Inspector's Stamp

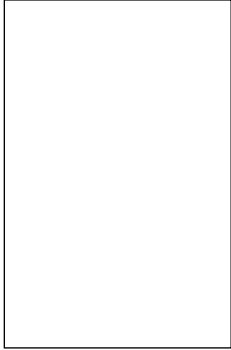
A large, empty rectangular box with a thin black border, intended for a quality inspector's stamp.

Sold by
(name and stamp of the seller)

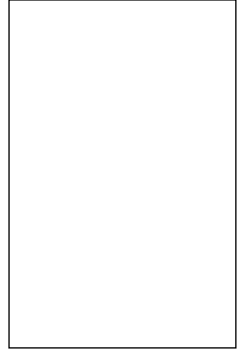
A large, empty rectangular box with a thin black border, intended for the name and stamp of the seller.

Manufacture Date

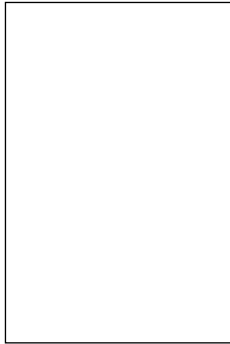
A large, empty rectangular box with a thin black border, intended for the manufacture date.

Purchase Date

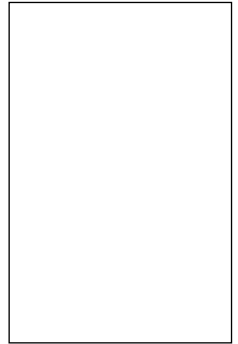
A large, empty rectangular box with a thin black border, intended for the purchase date.

